



**INSTALLATION INSTRUCTIONS FOR ESCORT/COBRA EZ MAG MOUNT  
RADAR DETECTORS**

Your rear view mirror has minimal clearance between the back side of the mirror and the mirror stem. It is very important that this mount is installed correctly to ensure mirror adjustability is retained.

**PLEASE READ THESE INSTRUCTIONS THOROUGHLY BEFORE INSTALLING THIS MOUNT**

**NOTE:** For illustration purposes, the mount and rear view mirror shown in these instructions may look slightly different than YOUR mount and rear view mirror.



ALUMINUM  
THREADED  
INSERT



UNSCREW  
HERE

1 - The magnet must be removed from the suction cup mount that the radar detector came with.

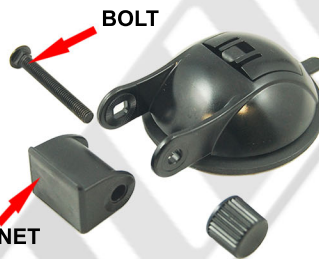

MAGNET

BOLT

2 - Unscrew and remove bolt, only the magnetic piece is used with the blendmount.

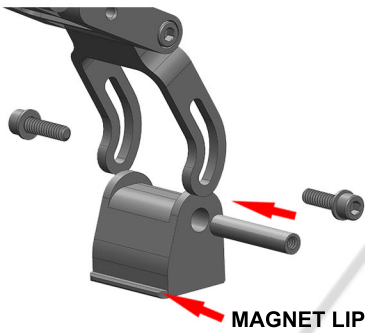

MAGNET LIP

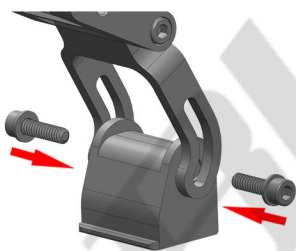

3 - Install aluminum threaded insert into magnet, and attach magnet onto blendmount with lip pointed in direction as shown.

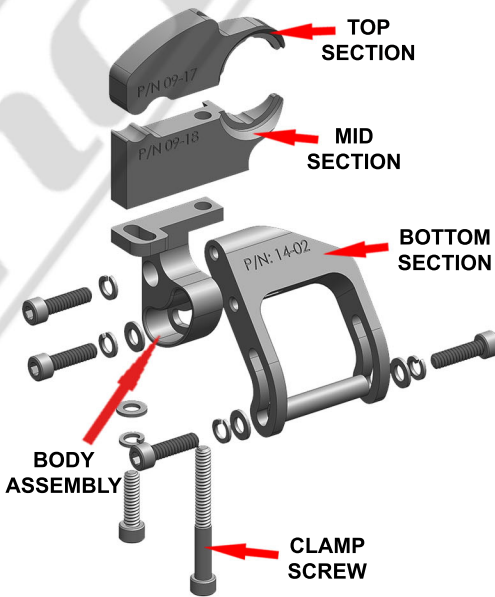

TOP  
SECTION

MID  
SECTION

BOTTOM  
SECTION

BODY  
ASSEMBLY

CLAMP  
SCREW

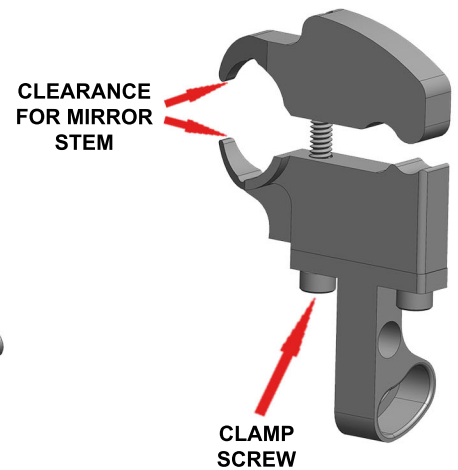

CLEARANCE  
FOR MIRROR  
STEM

CLAMP  
SCREW

4 - The Body Assembly must be removed to gain access to the CLAMP SCREW. Remove the two socket head screws as shown above. Be sure to remove the lock washer with the top screw along with the lock washer and flat washer with the bottom screw. Loosen the Clamp Screw so there is enough clearance between the TOP and MID SECTIONS to slide over the mirror stem.

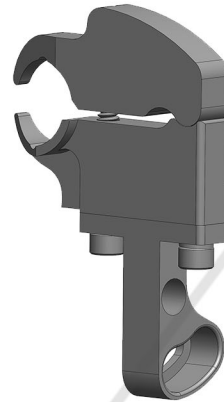

PIVOT POINT

TOP AND MID SECTIONS MUST TOUCH AT THE PIVOT POINT BEFORE CLAMP SCREW IS FULLY TIGHTENED

5 - While sitting in the passenger seat, place the mount over the mirror stem. Tighten the CLAMP SCREW until the mount starts to clamp onto the mirror stem. Position the mount as far forward as it will go and parallel to the bottom of the mirror before fully tightening.

6 - MAKE SURE THE TOP AND MID SECTIONS ARE TOUCHING AT THE PIVOT POINT. If you can not get them to touch at the pivot point, you may have an **incompatible mirror type for this mount.**

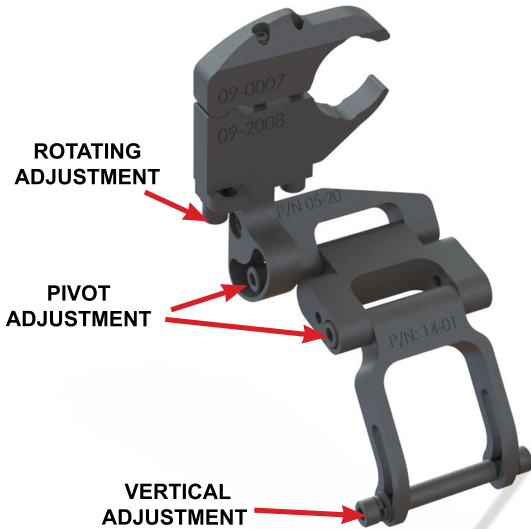

7 - Reinstall the body assembly. Be sure to include all lock washers with screws, and the lock and flat washer with the bottom socket head screw as shown above. Use the adjustments shown above to adjust the RD to your desired position. We recommend adjusting the RD as close to the bottom of mirror as possible. Be sure to tighten all screws after adjustments are made.



PUSH UP ON FACE AND TWIST TO REMOVE

8 - To remove the radar from the magnetic mount, simply tilt the face of the RD up and twist slightly to side, then the magnet will release.

**CAUTION**

**DO NOT** use this mount if it interferes with the adjustability or the operation of your rear view mirror in any way.

**DO NOT** use this mount if the radar detector creates an unsafe viewing obstruction.

**DO NOT ATTEMPT TO MODIFY THIS PRODUCT.** Consult the manufacturer for assistance.

All BlendMount products are accompanied with detailed installation instructions and adjustment tips. You are encouraged to contact customerservice@blendmount.com or call J28 Design at 1-888-497-8388 for further assistance.

Check the BlendMount Forum for installation tips and some vehicle specific installs.  
[www.blendmount.com](http://www.blendmount.com)

Your feedback is very important to us. Please email any questions or comments you have to [customerservice@blendmount.com](mailto:customerservice@blendmount.com)